

PRORIL

50 Hz

Serving a wide range of slurry transport applications, STORMY-P series pumps are designed for long wear life, low energy consumption, excellent performance, and easy maintenance. With patented ACrS Tech and rugged construction, these abrasion and corrosion resistant slurry pumps provide economical solutions for challenging slurry transportation.

Slurry and Sand Pump

STORMY 337P

Open Stand and Agitator Pump



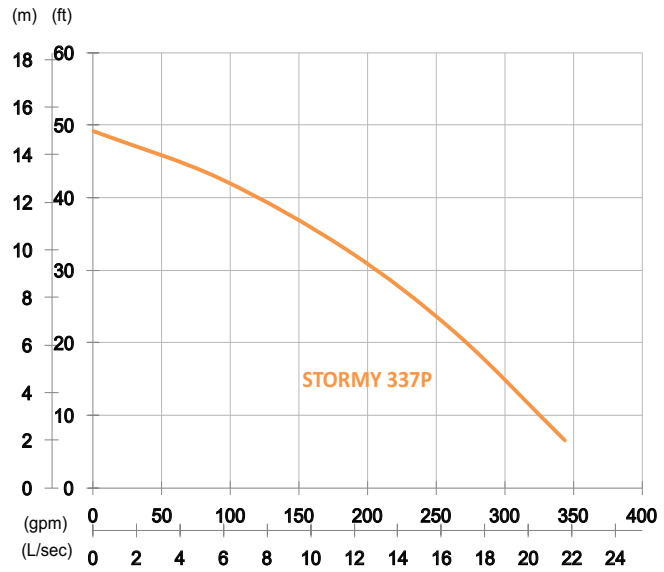

Shaft Speed : 1450 rpm

Outlet : 80mm, 3in

OUTPUT	HEAD	FLOW
3.7 kW	Rated : 10m, 33ft	Rated : 11.7 L/s, 185 gpm
5 HP	Max : 15m, 49ft	Max : 21.7 L/s, 343 gpm

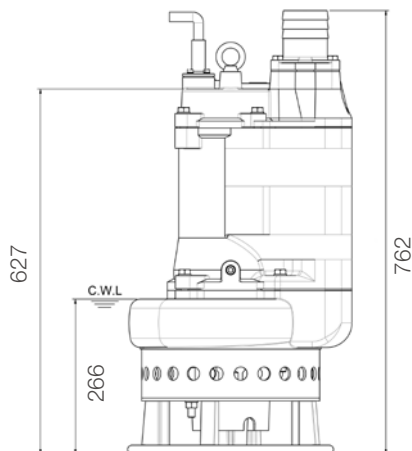
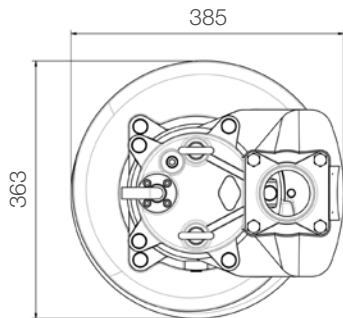

unit : mm

Weight : 110kg / 243 lbs

Pump Type		Electric Submersible Pumps
		3-Phase
Motor	Type	Induction Motor
	Poles	4 Pole
	Insulation	Class F
	Protector	Circle Thermal Protector
	Starter	D.O.L.
Lubricant		Food Grade (ISO VG32)
Impeller Type		Opened
Shaft Seal		Double Mechanical Seal Silicon Carbide VS Ceramic / Carbon
Bearings		C3 Shielded ball bearings
Cable		PVC (CSA Certified) / H07RN-F 10m (33ft) or longer upon request.
Materials	Pump Casing	Ductile Iron
	Impeller	Chromium Iron
	Motor Frame	Gray Iron
	Motor Shaft	Stainless Steel
	Wear Plate	Chromium Iron
	Agitator	Chromium Iron
Max. Liquid Temperature		40°C (104°F)
Max. Submersion Depth		20m (66ft)
pH Range		pH 5 - pH 8